

# DATA SHEET

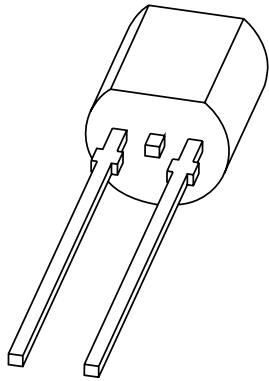

## **KTY81-1 series** Silicon temperature sensors

Product specification  
Supersedes data of 1996 Dec 06  
File under Discrete Semiconductors, SC17

1998 Mar 26

# Silicon temperature sensors

# KTY81-1 series

## DESCRIPTION

The temperature sensors in the KTY81-1 series have a positive temperature coefficient of resistance and are suitable for use in measurement and control systems. The sensors are encapsulated in the SOD70 leaded plastic package.

Tolerances of 0.5% or other special selections are available on request.

## MARKING

TYPE NUMBER	CODE
KTY81-110	110
KTY81-120	120
KTY81-121	121
KTY81-122	122
KTY81-150	150
KTY81-151	151
KTY81-152	152

## PINNING

PIN	DESCRIPTION
1	electrical contact
2	electrical contact
3	not to be connected to a potential

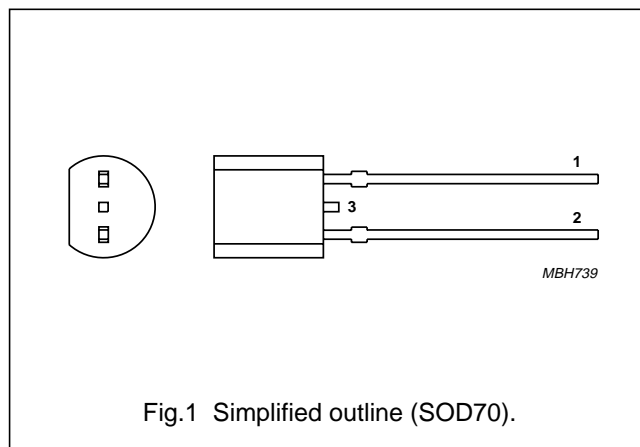

## QUICK REFERENCE DATA

SYMBOL	PARAMETER	CONDITIONS	MIN.	MAX.	UNIT
R <sub>25</sub>	sensor resistance	T <sub>amb</sub> = 25 °C; I <sub>cont</sub> = 1 mA			
	KTY81-110		990	1010	Ω
	KTY81-120		980	1020	Ω
	KTY81-121		980	1000	Ω
	KTY81-122		1000	1020	Ω
	KTY81-150		950	1050	Ω
	KTY81-151		950	1000	Ω
KTY81-152	1000	1050	Ω		
T <sub>amb</sub>	ambient operating temperature		-55	+150	°C

## Silicon temperature sensors

## KTY81-1 series

**LIMITING VALUES**

In accordance with the Absolute Maximum Rating System (IEC 134).

SYMBOL	PARAMETER	CONDITIONS	MIN.	MAX.	UNIT
$I_{\text{cont}}$	continuous sensor current	in free air; $T_{\text{amb}} = 25\text{ °C}$	–	10	mA
		in free air; $T_{\text{amb}} = 150\text{ °C}$	–	2	mA
$T_{\text{amb}}$	ambient operating temperature		–55	+150	°C

**CHARACTERISTICS**

$T_{\text{amb}} = 25\text{ °C}$ , in liquid, unless otherwise specified.

SYMBOL	PARAMETER	CONDITIONS	MIN.	TYP.	MAX.	UNIT
$R_{25}$	sensor resistance	$I_{\text{cont}} = 1\text{ mA}$				
	KTY81-110		990	–	1010	$\Omega$
	KTY81-120		980	–	1020	$\Omega$
	KTY81-121		980	–	1000	$\Omega$
	KTY81-122		1000	–	1020	$\Omega$
	KTY81-150		950	–	1050	$\Omega$
	KTY81-151		950	–	1000	$\Omega$
KTY81-152	1000	–	1050	$\Omega$		
TC	temperature coefficient		–	0.79	–	%/K
$R_{100}/R_{25}$	resistance ratio	$T_{\text{amb}} = 100\text{ °C}$ and $25\text{ °C}$	1.676	1.696	1.716	
$R_{-55}/R_{25}$	resistance ratio	$T_{\text{amb}} = -55\text{ °C}$ and $25\text{ °C}$	0.480	0.490	0.500	
$\tau$	thermal time constant; note 1	in still air	–	30	–	s
		in still liquid; note 2	–	5	–	s
		in flowing liquid; note 2	–	3	–	s
	rated temperature range		–55	–	+150	°C

**Notes**

- The thermal time constant is the time taken for the sensor to reach 63.2% of the total temperature difference. For example, if a sensor with a temperature of  $25\text{ °C}$  is moved to an environment with an ambient temperature of  $100\text{ °C}$ , the time for the sensor to reach a temperature of  $47.4\text{ °C}$  is the thermal time constant.
- Inert liquid, e.g. FC43 manufactured by the 3M company.

## Silicon temperature sensors

## KTY81-1 series

**Table 1** Ambient temperature, corresponding resistance, temperature coefficient and maximum expected temperature error for KTY81-110 and KTY81-120 $I_{\text{cont}} = 1 \text{ mA}$ .

AMBIENT TEMPERATURE		TEMP. COEFF. (%/K)	KTY81-110				KTY81-120			
(°C)	(°F)		RESISTANCE (Ω)			TEMP. ERROR (K)	RESISTANCE (Ω)			TEMP. ERROR (K)
			MIN.	TYP.	MAX.		MIN.	TYP.	MAX.	
-55	-67	0.99	475	490	505	±3.02	470	490	510	±4.02
-50	-58	0.98	500	515	530	±2.92	495	515	535	±3.94
-40	-40	0.96	552	567	582	±2.74	547	567	588	±3.78
-30	-22	0.93	609	624	638	±2.55	603	624	645	±3.62
-20	-4	0.91	669	684	698	±2.35	662	684	705	±3.45
-10	14	0.88	733	747	761	±2.14	726	747	769	±3.27
0	32	0.85	802	815	828	±1.91	793	815	836	±3.08
10	50	0.83	874	886	898	±1.67	865	886	907	±2.88
20	68	0.80	950	961	972	±1.41	941	961	982	±2.66
25	77	0.79	990	1000	1010	±1.27	980	1000	1020	±2.54
30	86	0.78	1029	1040	1051	±1.39	1018	1040	1061	±2.68
40	104	0.75	1108	1122	1136	±1.64	1097	1122	1147	±2.97
50	122	0.73	1192	1209	1225	±1.91	1180	1209	1237	±3.28
60	140	0.71	1278	1299	1319	±2.19	1265	1299	1332	±3.61
70	158	0.69	1369	1392	1416	±2.49	1355	1392	1430	±3.94
80	176	0.67	1462	1490	1518	±2.8	1447	1490	1532	±4.3
90	194	0.65	1559	1591	1623	±3.12	1543	1591	1639	±4.66
100	212	0.63	1659	1696	1733	±3.46	1642	1696	1750	±5.05
110	230	0.61	1762	1805	1847	±3.83	1744	1805	1865	±5.48
120	248	0.58	1867	1915	1963	±4.33	1848	1915	1982	±6.07
125	257	0.55	1919	1970	2020	±4.66	1899	1970	2040	±6.47
130	266	0.52	1970	2023	2077	±5.07	1950	2023	2097	±6.98
140	284	0.45	2065	2124	2184	±6.28	2043	2124	2205	±8.51
150	302	0.35	2145	2211	2277	±8.55	2123	2211	2299	±11.43

## Silicon temperature sensors

## KTY81-1 series

**Table 2** Ambient temperature, corresponding resistance, temperature coefficient and maximum expected temperature error for KTY81-121 and KTY81-122 $I_{\text{cont}} = 1 \text{ mA}$ .

AMBIENT TEMPERATURE		TEMP. COEFF. (%/K)	KTY81-121				KTY81-122			
(°C)	(°F)		RESISTANCE (Ω)			TEMP. ERROR (K)	RESISTANCE (Ω)			TEMP. ERROR (K)
			MIN.	TYP.	MAX.		MIN.	TYP.	MAX.	
-55	-67	0.99	471	485	500	±3.02	480	495	510	±3.02
-50	-58	0.98	495	510	524	±2.92	505	520	535	±2.92
-40	-40	0.96	547	562	576	±2.74	558	573	588	±2.74
-30	-22	0.93	603	617	632	±2.55	615	630	645	±2.55
-20	-4	0.91	662	677	691	±2.35	676	690	705	±2.35
-10	14	0.88	726	740	754	±2.14	741	755	769	±2.14
0	32	0.85	794	807	820	±1.91	810	823	836	±1.91
10	50	0.83	865	877	889	±1.67	883	895	907	±1.67
20	68	0.80	941	951	962	±1.41	960	971	982	±1.41
25	77	0.79	980	990	1000	±1.27	1000	1010	1020	±1.27
30	86	0.78	1018	1029	1041	±1.39	1039	1050	1062	±1.39
40	104	0.75	1097	1111	1125	±1.64	1120	1134	1148	±1.64
50	122	0.73	1180	1196	1213	±1.91	1204	1221	1238	±1.91
60	140	0.71	1266	1286	1305	±2.19	1291	1312	1332	±2.19
70	158	0.69	1355	1378	1402	±2.49	1382	1406	1430	±2.49
80	176	0.67	1447	1475	1502	±2.8	1477	1505	1533	±2.8
90	194	0.65	1543	1575	1607	±3.12	1574	1607	1639	±3.12
100	212	0.63	1642	1679	1716	±3.46	1676	1713	1750	±3.46
110	230	0.61	1745	1786	1828	±3.83	1780	1823	1865	±3.83
120	248	0.58	1849	1896	1943	±4.33	1886	1934	1982	±4.33
125	257	0.55	1900	1950	2000	±4.66	1938	1989	2041	±4.66
130	266	0.52	1950	2003	2056	±5.07	1989	2044	2098	±5.07
140	284	0.45	2044	2103	2162	±6.28	2085	2146	2206	±6.28
150	302	0.35	2124	2189	2254	±8.55	2167	2233	2299	±8.55

## Silicon temperature sensors

## KTY81-1 series

**Table 3** Ambient temperature, corresponding resistance, temperature coefficient and maximum expected temperature error for KTY81-150 and KTY81-151 $I_{\text{cont}} = 1 \text{ mA}$ .

AMBIENT TEMPERATURE		TEMP. COEFF. (%/K)	KTY81-150				KTY81-151			
(°C)	(°F)		RESISTANCE (Ω)			TEMP. ERROR (K)	RESISTANCE (Ω)			TEMP. ERROR (K)
			MIN.	TYP.	MAX.		MIN.	TYP.	MAX.	
-55	-67	0.99	456	490	524	±7.04	456	478	499	±4.52
-50	-58	0.98	479	515	550	±6.99	480	502	524	±4.45
-40	-40	0.96	530	567	605	±6.91	530	553	576	±4.3
-30	-22	0.93	584	624	663	±6.84	584	608	632	±4.16
-20	-4	0.91	642	684	725	±6.77	642	667	691	±4.01
-10	14	0.88	703	747	791	±6.69	704	729	753	±3.84
0	32	0.85	769	815	861	±6.61	770	794	819	±3.67
10	50	0.83	838	886	934	±6.51	839	864	889	±3.48
20	68	0.80	912	961	1010	±6.41	912	937	962	±3.28
25	77	0.79	950	1000	1050	±6.35	950	975	1000	±3.18
30	86	0.78	987	1040	1093	±6.55	988	1014	1040	±3.33
40	104	0.75	1064	1122	1181	±6.97	1064	1094	1124	±3.64
50	122	0.73	1143	1209	1274	±7.4	1144	1178	1212	±3.97
60	140	0.71	1226	1299	1371	±7.85	1227	1266	1305	±4.31
70	158	0.69	1313	1392	1472	±8.31	1314	1357	1401	±4.67
80	176	0.67	1402	1490	1577	±8.79	1404	1453	1501	±5.05
90	194	0.65	1495	1591	1687	±9.29	1497	1551	1606	±5.43
100	212	0.63	1591	1696	1801	±9.81	1593	1654	1714	±5.84
110	230	0.61	1690	1805	1919	±10.4	1692	1759	1827	±6.3
120	248	0.58	1791	1915	2039	±11.28	1792	1867	1942	±6.94
125	257	0.55	1840	1970	2099	±11.91	1842	1920	1999	±7.38
130	266	0.52	1889	2023	2158	±12.72	1891	1973	2055	±7.94
140	284	0.45	1980	2124	2269	±15.21	1982	2071	2161	±9.63
150	302	0.35	2057	2211	2365	±20.09	2059	2156	2252	±12.88

## Silicon temperature sensors

## KTY81-1 series

**Table 4** Ambient temperature, corresponding resistance, temperature coefficient and maximum expected temperature error for KTY81-152 $I_{\text{cont}} = 1 \text{ mA}$ .

AMBIENT TEMPERATURE		(%/K)	KTY81-152			
(°C)	(°F)		RESISTANCE (Ω)			TEMP. ERROR (K)
			MIN.	TYP.	MAX.	
-55	-67	0.99	480	502	525	±4.52
-50	-58	0.98	505	528	551	±4.45
-40	-40	0.96	558	582	606	±4.3
-30	-22	0.93	614	639	664	±4.16
-20	-4	0.91	675	701	726	±4.01
-10	14	0.88	740	766	792	±3.84
0	32	0.85	809	835	861	±3.67
10	50	0.83	882	908	934	±3.48
20	68	0.80	959	985	1011	±3.28
25	77	0.79	1000	1025	1050	±3.18
30	86	0.78	1038	1066	1093	±3.33
40	104	0.75	1119	1150	1182	±3.64
50	122	0.73	1203	1239	1275	±3.97
60	140	0.71	1290	1331	1372	±4.31
70	158	0.69	1381	1427	1473	±4.67
80	176	0.67	1476	1527	1578	±5.05
90	194	0.65	1573	1631	1688	±5.43
100	212	0.63	1674	1738	1802	±5.84
110	230	0.61	1779	1850	1921	±6.3
120	248	0.58	1884	1963	2041	±6.94
125	257	0.55	1937	2019	2101	±7.38
130	266	0.52	1988	2074	2160	±7.94
140	284	0.45	2084	2178	2271	±9.63
150	302	0.35	2165	2266	2367	±12.88

Silicon temperature sensors

KTY81-1 series

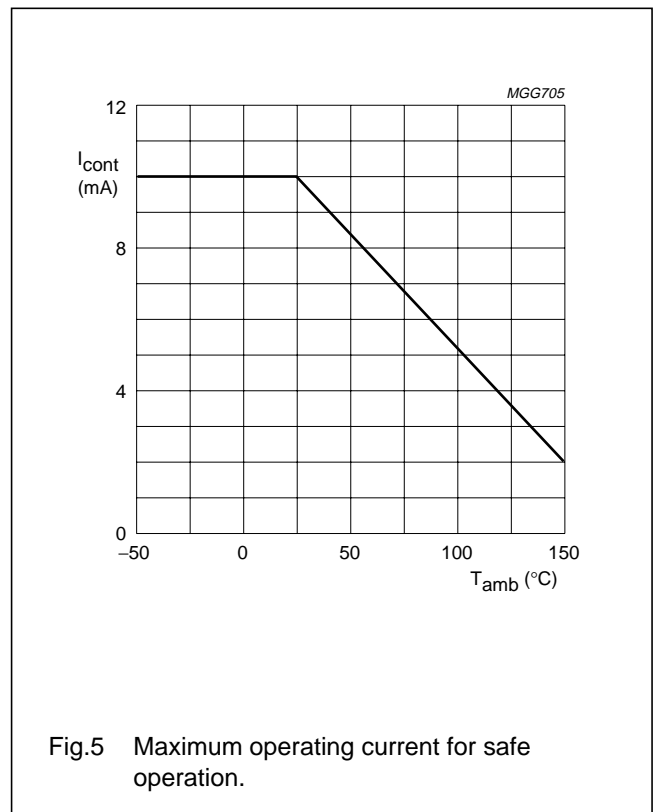
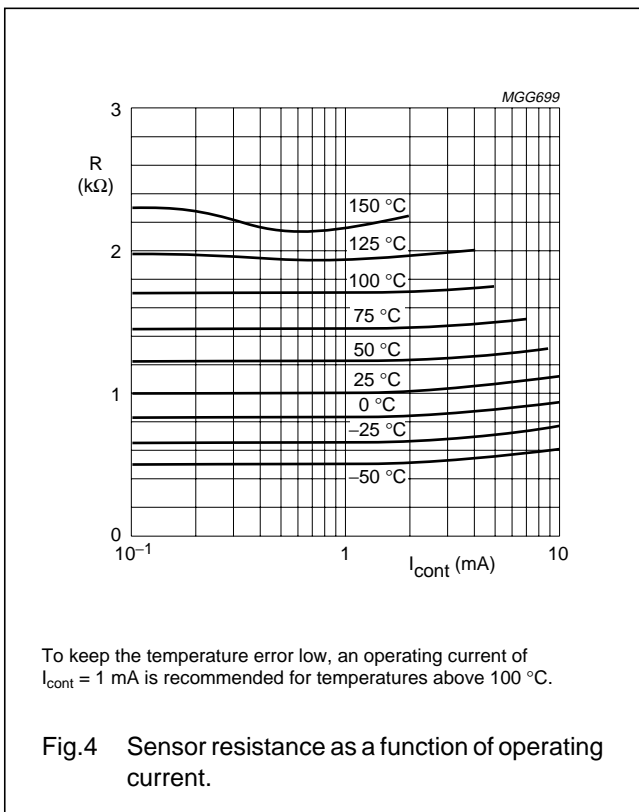
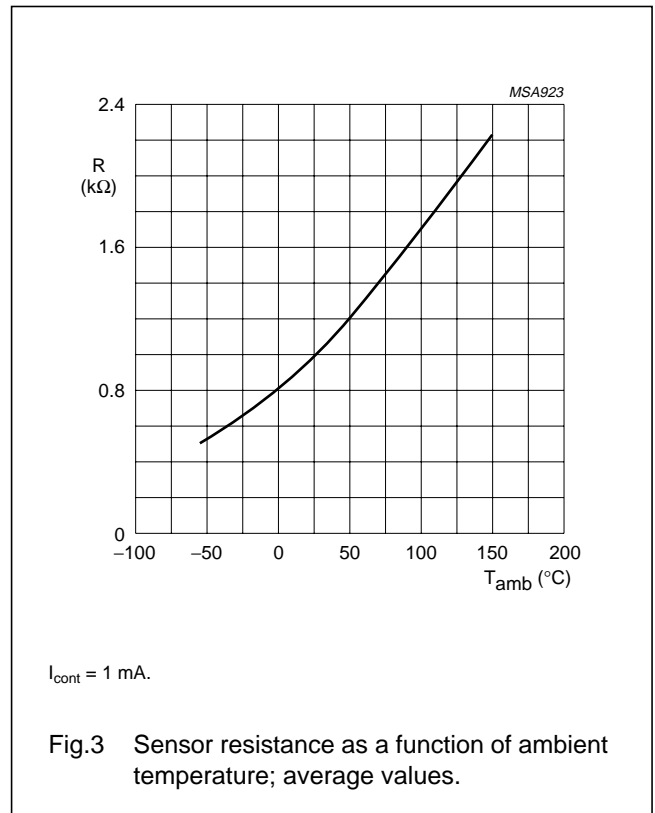
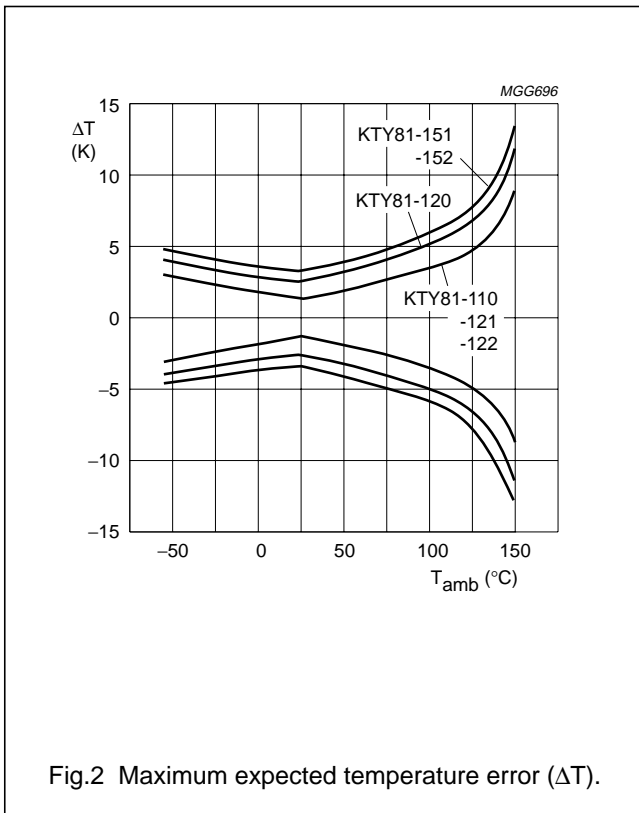



Silicon temperature sensors

KTY81-1 series

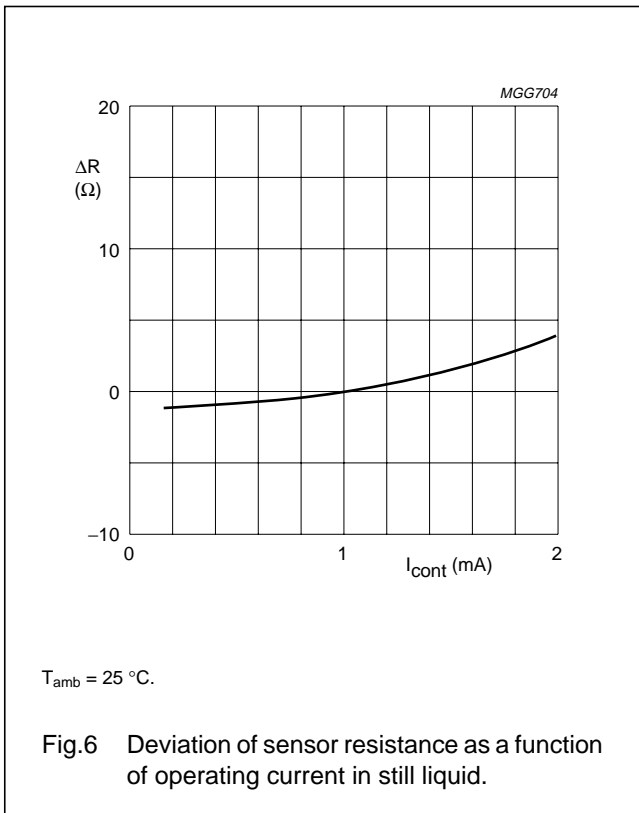

**APPLICATION INFORMATION**

SYMBOL	PARAMETER	CONDITIONS	TYP.	UNIT
$\Delta R_{25}$	drift of sensor resistance at 25 °C	10000 hours continuous operation; $T_{amb} = 150\text{ }^{\circ}\text{C}$	1.6	$\Omega$

Silicon temperature sensors

KTY81-1 series

**PACKAGING**

Sensors in SOD70 encapsulation are delivered in bulk packaging and also in reel packaging for automatic placement on hybrid circuits and printed-circuit boards (see Fig.7).

**Note:** Types in bulk packaging have a lead-to-lead distance of 2.54 millimetres, whereas the distance for types packaged on reel is 5.08 millimetres.

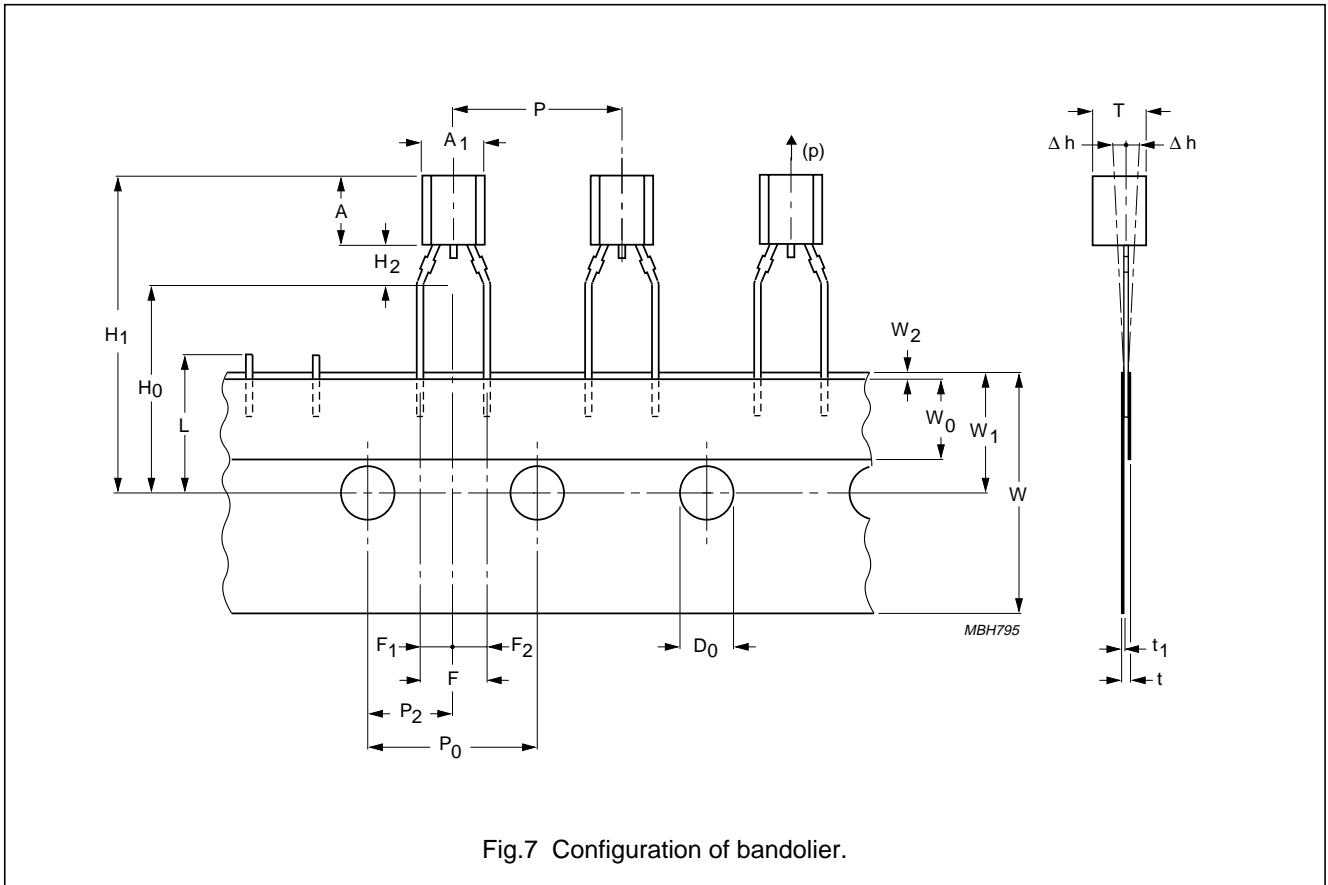

Fig.7 Configuration of bandolier.

## Silicon temperature sensors

## KTY81-1 series

Table 5 Tape specification

SYMBOL	DIMENSION	SPECIFICATIONS					REMARKS
		MIN.	NOM.	MAX.	TOL.	UNIT	
A <sub>1</sub>	body width	4.4	–	4.8	–	mm	
A	body height	5	–	5.2	–	mm	
T	body thickness	3.6	–	3.9	–	mm	
P	pitch of component	–	12.7	–	±1	mm	
P <sub>0</sub>	feed hole pitch	–	12.7	–	±0.3	mm	
	cumulative pitch error	–	–	–	±0.1		note 1
P <sub>2</sub>	feed hole centre to component centre	–	6.35	–	±0.4	mm	to be measured at bottom of clinch
F	lead-to-lead distance	–	5.08	–	+0.6/–0.2	mm	
Δh	component alignment	–	0	1	–	mm	at top of body
W	tape width	–	18	–	±0.5	mm	
W <sub>0</sub>	hold-down tape width	–	6	–	±0.2	mm	
W <sub>1</sub>	hole position	–	9	–	+0.7/–0.5	mm	
W <sub>2</sub>	hold-down tape position	–	0.5	–	±0.2	mm	
H <sub>0</sub>	lead wire clinch height	–	16.5	–	±0.5	mm	
H <sub>1</sub>	component height	–	–	23.25	–	mm	
L	length of snapped leads	–	–	11	–	mm	
D <sub>0</sub>	feed hole diameter	–	4	–	±0.2	mm	
t	total tape thickness	–	–	1.2	–	mm	t <sub>1</sub> = 0.3 to 0.6
F <sub>1</sub> , F <sub>2</sub>	lead to snapped lead distance	–	2.54	–	+0.4/–0.2	mm	
H <sub>2</sub>	clinch height	–	2.5	–	+0.5/0	mm	
(p)	pull-out force	6	–	–	–	N	

**Note**

1. Measured over 20 devices.

Silicon temperature sensors

KTY81-1 series

PACKAGE OUTLINE

Plastic near cylindrical single-ended package; 2 in-line leads

SOD70

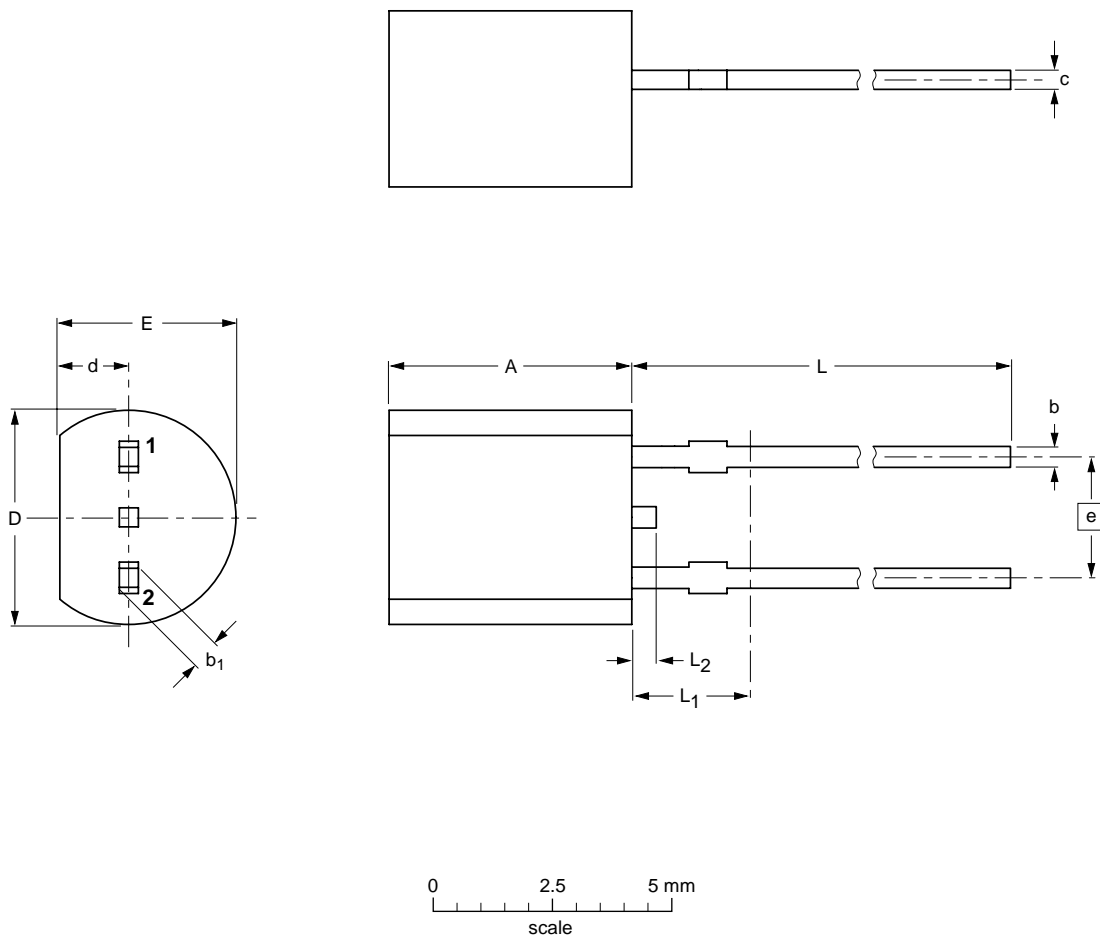

DIMENSIONS (mm are the original dimensions)

UNIT	A	b	b <sub>1</sub>	c	D	d	E	e	L	L <sub>1</sub> <sup>(1)</sup> max.	L <sub>2</sub>
mm	5.2 5.0	0.48 0.40	0.66 0.56	0.45 0.40	4.8 4.4	1.7 1.4	4.2 3.6	2.54	14.5 12.7	2.5	0.7 0.5

Notes

1. Terminal dimensions within this zone are uncontrolled to allow for flow of plastic and terminal irregularities.

OUTLINE VERSION	REFERENCES				EUROPEAN PROJECTION	ISSUE DATE
	IEC	JEDEC	EIAJ			
SOD70						97-05-30

## Silicon temperature sensors

## KTY81-1 series

**DEFINITIONS**

<b>Data Sheet Status</b>	
Objective specification	This data sheet contains target or goal specifications for product development.
Preliminary specification	This data sheet contains preliminary data; supplementary data may be published later.
Product specification	This data sheet contains final product specifications.
<b>Limiting values</b>	
Limiting values given are in accordance with the Absolute Maximum Rating System (IEC 134). Stress above one or more of the limiting values may cause permanent damage to the device. These are stress ratings only and operation of the device at these or at any other conditions above those given in the Characteristics sections of the specification is not implied. Exposure to limiting values for extended periods may affect device reliability.	
<b>Application information</b>	
Where application information is given, it is advisory and does not form part of the specification.	

**LIFE SUPPORT APPLICATIONS**

These products are not designed for use in life support appliances, devices, or systems where malfunction of these products can reasonably be expected to result in personal injury. Philips customers using or selling these products for use in such applications do so at their own risk and agree to fully indemnify Philips for any damages resulting from such improper use or sale.