

SA52-11EWA/GWA/YWA/SRWA

SC52-11EWA/GWA/YWA/SRWA

### Features

- 0.52 INCH DIGIT HEIGHT.
- LOW CURRENT OPERATION.
- EXCELLENT CHARACTER APPEARANCE.
- EASY MOUNTING ON P.C. BOARDS OR SOCKETS.
- I.C. COMPATIBLE.
- CATEGORIZED FOR LUMINOUS INTENSITY, YELLOW AND GREEN CATEGORIZED FOR COLOR.
- MECHANICALLY RUGGED.
- STANDARD : GRAY FACE, WHITE SEGMENT.

### Description

The High Efficiency Red source color devices are made with Gallium Arsenide Phosphide on Gallium Phosphide Orange Light Emitting Diode.

The Green source color devices are made with Gallium Phosphide Green Light Emitting Diode.

The Yellow source color devices are made with Gallium Arsenide Phosphide on Gallium Phosphide Yellow Light Emitting Diode.

The Super Bright Red source color devices are made with Gallium Aluminum Arsenide Red Light Emitting Diode.

### Package Dimensions & Internal Circuit Diagram

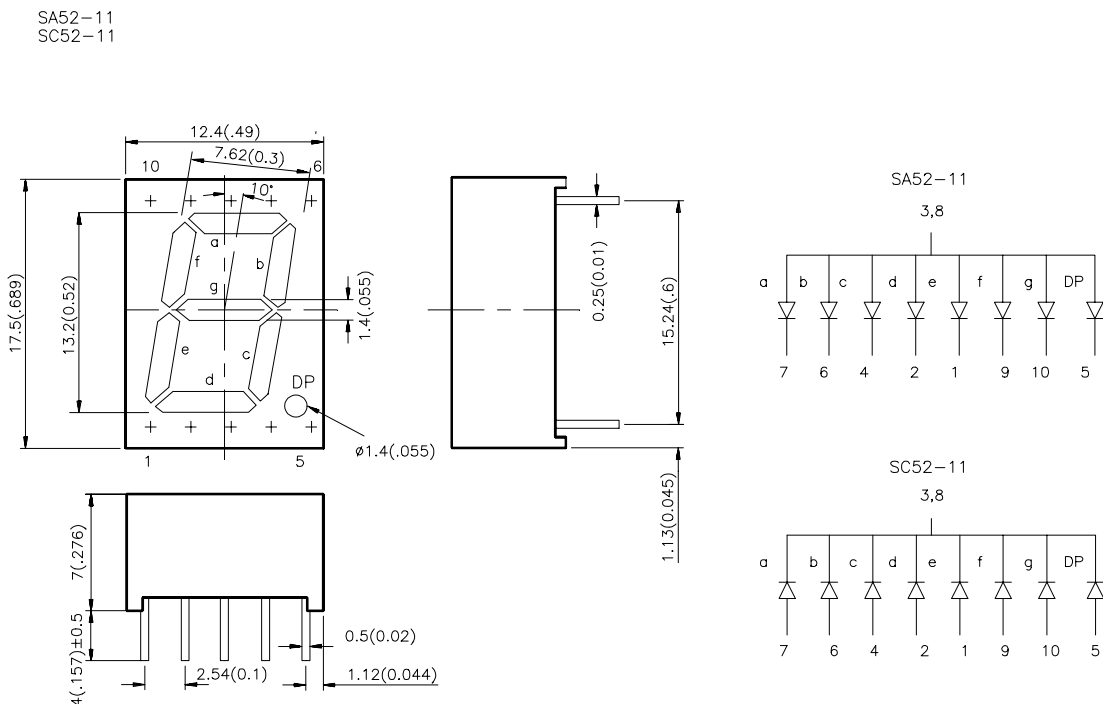

#### Notes:

1. All dimensions are in millimeters (inches), Tolerance is  $\pm 0.25(0.01)$  unless otherwise noted.
2. Specifications are subject to change without notice.

## Selection Guide

| Part No.    | Dice                            | Iv (ucd)<br>@ 10 mA |       | Description                      |
|-------------|---------------------------------|---------------------|-------|----------------------------------|
|             |                                 | Min.                | Typ.  |                                  |
| SA52-11EWA  | HIGH EFFICIENCY RED (GaAsP/GaP) | 1900                | 6400  | Common Anode, Rt. Hand Decimal   |
| SC52-11EWA  |                                 |                     |       | Common Cathode, Rt. Hand Decimal |
| SA52-11GWA  | GREEN (GaP)                     | 3000                | 10500 | Common Anode, Rt. Hand Decimal   |
| SC52-11GWA  |                                 |                     |       | Common Cathode, Rt. Hand Decimal |
| SA52-11YWA  | YELLOW (GaAsP/GaP)              | 1900                | 4700  | Common Anode, Rt. Hand Decimal   |
| SC52-11YWA  |                                 |                     |       | Common Cathode, Rt. Hand Decimal |
| SA52-11SRWA | SUPER BRIGHT RED (GaAlAs)       | 8000                | 24000 | Common Anode, Rt. Hand Decimal   |
| SC52-11SRWA |                                 |                     |       | Common Cathode, Rt. Hand Decimal |

## Electrical / Optical Characteristics at T<sub>A</sub>=25°C

| Symbol                | Parameter               | Device   | Typ.                      | Max.                     | Units | Test Conditions |
|-----------------------|-------------------------|--|---------------------------|--------------------------|-------|-----------------|
| $\lambda_{peak}$      | Peak Wavelength         | High Efficiency Red<br>Green<br>Yellow<br>Super Bright Red | 627<br>565<br>590<br>660  |                          | nm    | IF=20mA         |
| $\lambda_D$           | Dominate Wavelength     | High Efficiency Red<br>Green<br>Yellow<br>Super Bright Red | 625<br>568<br>588<br>640  |                          | nm    | IF=20mA         |
| $\Delta\lambda_{1/2}$ | Spectral Line Halfwidth | High Efficiency Red<br>Green<br>Yellow<br>Super Bright Red | 45<br>30<br>35<br>20      |                          | nm    | IF=20mA         |
| C                     | Capacitance             | High Efficiency Red<br>Green<br>Yellow<br>Super Bright Red | 15<br>15<br>20<br>45      |                          | pF    | VF=0V;f=1MHz    |
| V <sub>F</sub>        | Forward Voltage         | High Efficiency Red<br>Green<br>Yellow<br>Super Bright Red | 2.0<br>2.2<br>2.1<br>1.85 | 2.5<br>2.5<br>2.5<br>2.5 | V     | IF=20mA         |
| I <sub>R</sub>        | Reverse Current         | All  |                           | 10                       | uA    | VR = 5V         |

## Absolute Maximum Ratings at $T_A=25^\circ\text{C}$

| Parameter                     | High Efficiency Red | Green | Yellow | Super Bright Red | Units |
|-------------------------------|---------------------|-------|--------|------------------|-------|
| Power dissipation             | 105                 | 105   | 105    | 100              | mW    |
| DC Forward Current            | 30                  | 25    | 30     | 30               | mA    |
| Peak Forward Current [1]      | 160                 | 140   | 140    | 155              | mA    |
| Reverse Voltage               | 5                   | 5     | 5      | 5                | V     |
| Operating/Storage Temperature | -40°C To +85°C      |       |        |                  |       |
| Lead Solder Temperature [2]   | 260°C For 5 Seconds |       |        |                  |       |

**Notes:**

- 1/10 Duty Cycle, 0.1ms Pulse Width.
- 4mm below package base.

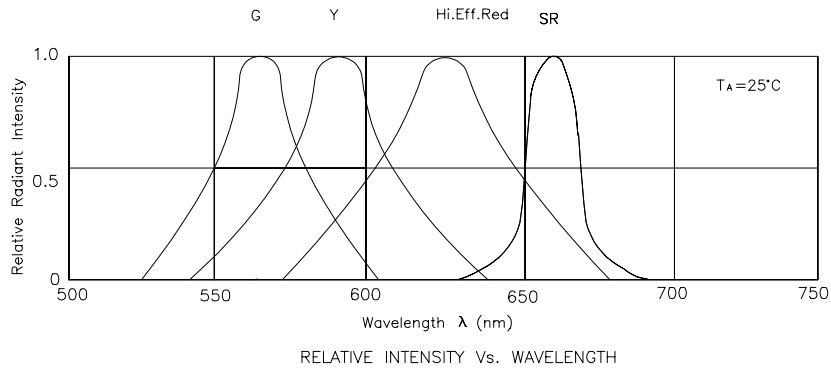

## High Efficiency Red

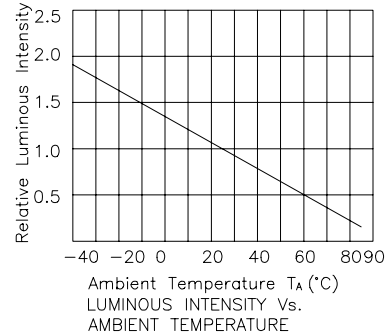
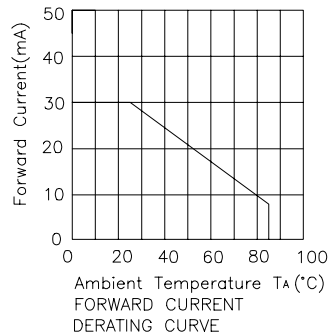
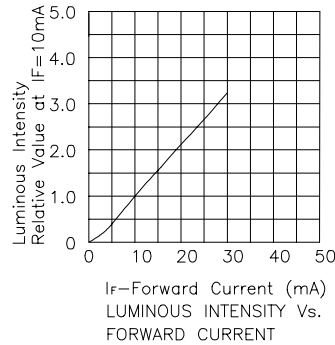
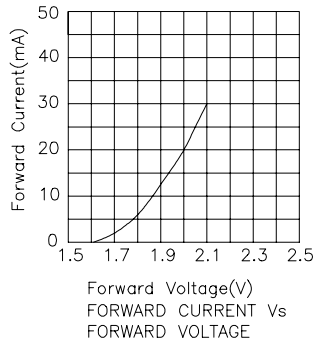

## Green

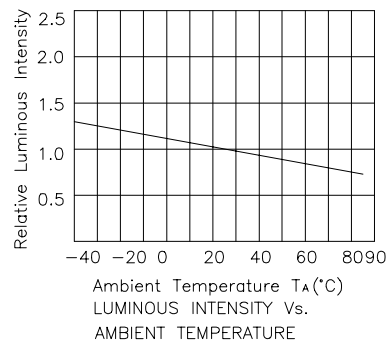
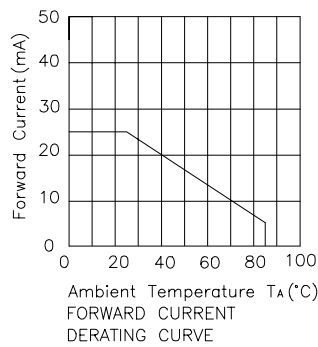
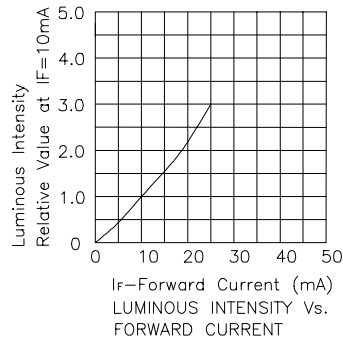
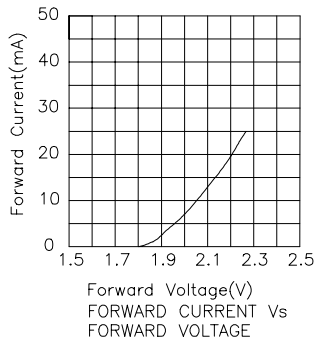

## Yellow

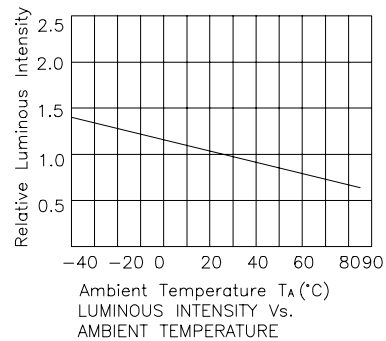
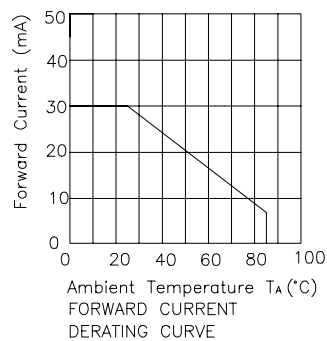
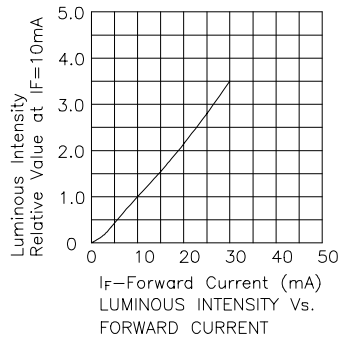
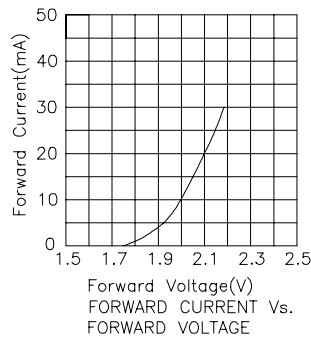

## Super Bright Red

